

## TIPS AND TROUBLESHOOTING

ISSUE	SOLUTION
UNIT WILL NOT OPERATE	<ul style="list-style-type: none"><li>• Make sure unit is properly plugged in and outlet is energized.</li><li>• Make sure unit turned ON.</li><li>• Make sure filters are properly installed and rear grill is seated correctly.</li></ul>
DECREASED AIR FLOW	<ul style="list-style-type: none"><li>• Make sure nothing is blocking air inlet and filtered air outlets.</li><li>• Check condition of the filter and replace if necessary.</li></ul>
EXCESSIVE NOISE	<ul style="list-style-type: none"><li>• Make sure parts are firmly positioned in place.</li><li>• Remove plastic bags from filters.</li></ul>

### LEARNING MORE

For more information about your air purifier and other Sunbeam® products, visit our website at [www.sunbeampets.com](http://www.sunbeampets.com) or call 1-866-537-2249.

## WARRANTY INFORMATION

### 3 YEAR LIMITED WARRANTY

Sunbeam Products, Inc. doing business as Jarden Consumer Solutions or if in Canada, Sunbeam Corporation (Canada) Limited doing business as Jarden Consumer Solutions (collectively "JCS") warrants that for a period of three years from the date of purchase, this product will be free from defects in material and workmanship. JCS, at its option, will repair or replace this product or any component of the product found to be defective during the warranty period. Replacement will be made with a new or remanufactured product or component. If the product is no longer available, replacement may be made with a similar product of equal or greater value. This is your exclusive warranty. Do NOT attempt to repair or adjust any electrical or mechanical functions on this product. Doing so will void this warranty.

This warranty is valid for the original retail purchaser from the date of initial retail purchase and is not transferable. Keep the original sales receipt. Proof of purchase is required to obtain warranty performance. JCS dealers, service centers, or retail stores selling JCS products do not have the right to alter, modify or any way change the terms and conditions of this warranty.

This warranty does not cover normal wear of parts or damage resulting from any of the following: negligent use or misuse of the product, use on improper voltage or current, use contrary to the operating instructions, disassembly, repair or alteration by anyone other than JCS or an authorized JCS service center. Further, the warranty does not cover: Acts of God, such as fire, flood, hurricanes and tornadoes.

#### What are the limits on JCS's Liability?

JCS shall not be liable for any incidental or consequential damages caused by the breach of any express, implied or statutory warranty or condition.

Except to the extent prohibited by applicable law, any implied warranty or condition of merchantability or fitness for a particular purpose is limited in duration to the duration of the above warranty.

JCS disclaims all other warranties, conditions or representations, express, implied, statutory or otherwise.

JCS shall not be liable for any damages of any kind resulting from the purchase, use or misuse of, or inability to use the product including incidental, special, consequential or similar damages or loss of profits, or for any breach of contract, fundamental or otherwise, or for any claim brought against purchaser by any other party.

Some provinces, states or jurisdictions do not allow the exclusion or limitation of incidental or consequential damages or limitations on how long an implied warranty lasts, so the above limitations or exclusion may not apply to you.

This warranty gives you specific legal rights, and you may also have other rights that vary from province to province, state to state or jurisdiction to jurisdiction.

#### How to Obtain Warranty Service

##### In the U.S.A. and Canada

If you have any question regarding this warranty or would like to obtain warranty service, please call 1-866-537-2249 and a convenient service center address will be provided to you.

In the U.S.A., this warranty is offered by Sunbeam Products, Inc. doing business as Jarden Consumer Solutions located in Boca Raton, Florida 33431. In Canada, this warranty is offered by Sunbeam Corporation (Canada) Limited doing business as Jarden Consumer Solutions, located at 20 B Hereford Street, Brampton, Ontario L6Y 0M1. If you have any other problem or claim in connection with this product, please write our Consumer Service Department. **PLEASE DO NOT RETURN THIS PRODUCT TO ANY OF THESE ADDRESSES OR TO THE PLACE OF PURCHASE.**

To register your product visit our web site

[www.sunbeampets.com](http://www.sunbeampets.com)

© 2011 Sunbeam Products, Inc. doing business as Jarden Consumer Solutions. All rights reserved. Distributed by Sunbeam Products, Inc. doing business as Jarden Consumer Solutions, Boca Raton, Florida 33431.

# Sunbeam®



## Owner's Guide

HAP424 series



## HEPA-Type Medium Tower

# Air Purifier

 with Optional Ionizer

**PLEASE READ AND SAVE THESE IMPORTANT INSTRUCTIONS**

## IMPORTANT SAFEGUARDS

When using electrical appliances, basic safety precautions should always be followed to reduce the risk of fire, electric shock, and injury to persons. These precautions include:

1. Read all instructions before using the appliance.
2. To avoid fire or shock hazard, plug the appliance directly into a 120V AC electrical outlet.
3. If the filter is covered by a bag when shipped, remove plastic bag before use.
4. Keep the cord out of heavy traffic areas. To avoid fire hazard, NEVER put the cord under rugs, near heat registers, radiators, stoves, or heaters.
5. To protect against electrical hazards, DO NOT immerse the appliance in water or other liquids. Do not use near water.
6. Close supervision is necessary when any appliance is used by or near children, or disabled persons.
7. Always unplug the air purifier before moving or cleaning the unit, opening the grill, changing the filters and whenever the unit is not in use. To disconnect the unit, be sure to pull the plug and not the cord.
8. NEVER drop or insert any objects into the openings of the unit.
9. DO NOT operate any appliance with a damaged cord or plug. If the motor fan fails to operate or the unit has been dropped or damaged in any manner, return appliance to manufacturer for examination and/or repair.
10. Use appliance only for intended household use as described in this manual. Any other use not recommended by the manufacturer may cause fire, electric shock, or injury to persons. The use of attachments not recommended or sold by Jarden Consumer Solutions may cause hazards.
11. DO NOT use outdoors.
12. NEVER place on a soft surface such as a bed or sofa as this could cause the unit to tip over and block the air inlet or outlet grills.
13. Keep unit away from heated surfaces and open flames.

14. DO NOT attempt to repair or adjust any electrical or mechanical functions on this unit. Doing so will void your warranty. The inside of the unit contains no user serviceable parts. All servicing should be performed by Jarden Consumer Solutions or an authorized Jarden Consumer Solutions Center.
15. DO NOT place anything on top of unit.
16. NEVER use detergents, gasoline, glass purifier, furniture polish, paint thinner, or other household solvents to clean any part of the appliance.
17. Always turn the appliance off before unplugging it.
18. The ionizer in this appliance produces less ozone than the UL established limits of 50ppb. However, in high concentrations, ozone can be harmful to birds and small pets. To prevent ozone buildup, we suggest using the ionizer in well ventilated areas with the fan on.
19. This appliance should only be used in a room with temperatures between 40° F and 110° F.
20. WARNING: To reduce the risk of fire or electric shock, DO NOT use this appliance with any solid-state speed control device.

## PLEASE SAVE THESE IMPORTANT SAFETY INSTRUCTIONS

### PLUG SAFETY

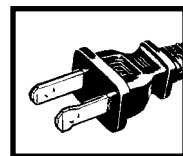

**CAUTION:** To reduce the risk of electric shock, **THIS PRODUCT HAS A POLARIZED PLUG** (one blade is wider than the other).

This plug will fit into a polarized outlet only one way. If the plug does not fit fully into the outlet, reverse the plug. If it still does not fit, contact qualified personnel to install the proper outlet. **DO NOT ALTER THE PLUG IN ANY WAY.**

## FEATURES

### CORD SAFETY

- The length of cord used on this appliance was selected to reduce tangling or tripping hazards.
- If a longer cord is necessary, an approved extension cord may be used. The electrical rating of the extension cord must be equal to or greater than the electrical rating of the air purifier (see rating label marked on product).
- Care must be taken to arrange the extension cord so that it will not drape over the countertop or tabletop where it can be pulled on by children or accidentally tripped over.

### GET TO KNOW YOUR AIR PURIFIER

- Your Sunbeam® air purifier features a HEPA-Type filter that removes up to 99% of airborne dust and pollen as small as 2 microns, and helps reduce smoke, mold spores and pet dander from air passing through the filter.
- Arm & Hammer® baking soda and carbon help absorb and eliminate household odors.
- Optional ionizer naturally improves performance and helps freshen the air.

### IONIZER

This appliance has an optional ionizer feature which, when turned on, releases negative ions into outgoing filtered air to help the air purification process.

#### What Are Ions?

Ions are tiny particles that carry a positive or negative charge. They exist naturally around us: in the air, water, and ground. Both positive and negative ions are colorless, odorless, and harmless.

#### How Does The Ionizer Work?

Negative ions help air purification by attaching themselves to very small airborne particles in the room. These particles take on a negative charge and may join with positively

charged particles such as dust, pollen, smoke, and pet dander to form larger particles. These larger particles are then more easily captured by the filter system.

#### Important Notes:

Your ionizer may produce an occasional popping or cracking sound. This is normal and occurs when a small buildup of ions is discharged.

After extended use, you may notice dust around the grills or front panel. This is caused by negative ions exiting the air outlet, evidence of the ionizer's air cleaning effectiveness. You can remove the dust with a soft brush or clean, damp cloth.

Larger particles may be attracted to positively charged surfaces throughout the home, like walls or floors.

- This may occur more frequently when the filter is nearing the end of its useful product life and unable to capture as many charged particles.
- Excessive amounts of pet dander, dust, or smoke may decrease the life expectancy of the filter and interfere with the ionization process.

To help prevent particles from attracting to surfaces throughout your home:

- You may want to run the ionizer less often.
- Check the condition of the filter more frequently.

**CAUTION:** The ionizer in this appliance produces less ozone than the UL\* established limits of 50ppb. However, in high concentrations, ozone can be harmful to birds and small pets. The ionizer feature is not recommended for use in poorly ventilated areas where small animals are present.



### HEPA-TYPE FILTER

HEPA (High Efficiency Particulate Air) filters are designed to remove up to 99% of airborne pollutants, at 2 microns or larger, from the air that passes through them. These include tobacco smoke, household dust, pet dander and pollen.

\*Tested and listed by the Underwriters Laboratories, Inc.

## FEATURES – OPERATIONS

### HIGH, MEDIUM AND LOW SPEED SETTINGS

For optimum air filtration, operate your Sunbeam® air purifier continuously on the MEDIUM (  ) setting. Its rugged motor has been designed to give many years of use. For quieter operation (such as in a bedroom), select the LOW (  ) setting. When high levels of air pollution are present, select the HI (  ) setting to quickly circulate and filter the room air.





### FILTER DATE WHEEL

This convenient feature helps you keep track of when to change the filter.

### BEFORE USE

1. Carefully unpack your Air Purifier. Select a firm level place where there are no obstructions to the air inlet or filtered air outlet.
2. If the filter is covered by a bag when shipped, remove plastic bag before use and place filters into unit.
3. DO NOT POINT FILTERED AIR OUTLET TOWARDS WALL.

### OPERATING INSTRUCTIONS

1. Plug into a 120V AC electrical outlet.
2. Select the desired operating speed from HIGH (  ), MEDIUM (  ) or LOW (  ) by moving the knob to the desired setting.
3. To release negative ions into the filtered air, turn the ionizer knob to ON (  ) and the light will illuminate.

#### NOTE:

The ionizer will not work unless the unit is running. For optimum air filtration, it is recommended to operate the air purifier continuously. Its rugged motor has been designed to give many years of use.

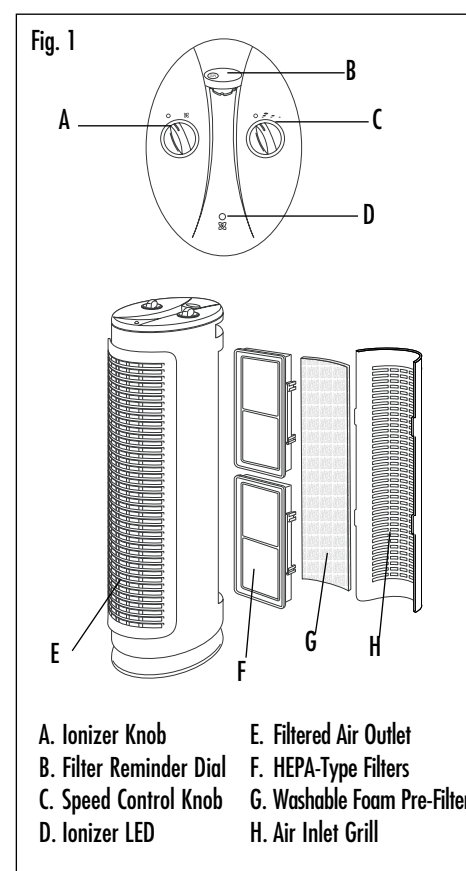

- A. Ionizer Knob  
B. Filter Reminder Dial  
C. Speed Control Knob  
D. Ionizer LED  
E. Filtered Air Outlet  
F. HEPA-Type Filters  
G. Washable Foam Pre-Filter  
H. Air Inlet Grill

## CLEANING / MAINTENANCE FILTER REPLACEMENT

### CLEANING/MAINTENANCE INSTRUCTIONS

1. Turn the air purifier off and unplug it before cleaning.
2. The outside of the air purifier can be cleaned with a soft, clean dampened cloth.
3. The rear air inlet grill can be removed and washed in warm soapy water (not dishwasher safe). Dry before replacing in the unit.
4. The filtered air outlet can be cleaned of dust with a small, soft brush.
5. If you wish to clean the inside of the air purifier, please only use a dry, soft cloth to wipe it down.

**WARNING:** Do not allow moisture to come in contact with the main housing of the air purifier.

### FILTER REPLACEMENT INSTRUCTIONS

#### IMPORTANT:

- DO NOT attempt to wash and re-use the HEPA-type filter.

#### NOTE:

Every few weeks, check the condition of filters. Filter life will vary, depending on air quality and usage. Under normal conditions of continuous use, the HEPA-type filter will operate efficiently for 3-6 months.

#### To replace your filter:

1. Turn off and unplug the air purifier.
2. Open the air inlet grill and examine the foam prefilter. Remove any dust or lint, and wash in warm soapy water. Rinse, drip dry, and place back into grill inlet.
3. Remove used filter from the unit by pulling it gently towards you and discard it. DO NOT attempt to clean the old HEPA-type filter.
4. Install the new HAPF30 HEPA-type filter into the unit. This model utilizes a hang tab and filter clips to insure that the filter is properly in place. Before replacing the filter, make sure that the hang tab is securely in place. The clip can only be attached to the tabs on the filter one way. The filter clip should easily slide onto the filter hang tab with only a small amount of pressure. **DO NOT** use force while attaching the clip to the filter. (Fig. 2)
5. Align the clip on the side of HEPA-type filter with rails on the inside of the purifier unit. Gently slide the filter onto the rail. (Fig. 3)
6. Replace air inlet grill.

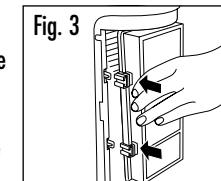
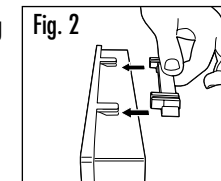

Air Purifier Model Number	Filter Quantity Needed	Filter Model Number	Filter Description
HAP424	2	HAPF30 A Filter	HEPA-type Filter